

GCE

Chemistry A

Advanced Subsidiary GCE

Unit F322: Chains, Energy and Resources

Mark Scheme for January 2013

OCR (Oxford Cambridge and RSA) is a leading UK awarding body, providing a wide range of qualifications to meet the needs of candidates of all ages and abilities. OCR qualifications include AS/A Levels, Diplomas, GCSEs, Cambridge Nationals, Cambridge Technicals, Functional Skills, Key Skills, Entry Level qualifications, NVQs and vocational qualifications in areas such as IT, business, languages, teaching/training, administration and secretarial skills.

It is also responsible for developing new specifications to meet national requirements and the needs of students and teachers. OCR is a not-for-profit organisation; any surplus made is invested back into the establishment to help towards the development of qualifications and support, which keep pace with the changing needs of today's society.

This mark scheme is published as an aid to teachers and students, to indicate the requirements of the examination. It shows the basis on which marks were awarded by examiners. It does not indicate the details of the discussions which took place at an examiners' meeting before marking commenced.

All examiners are instructed that alternative correct answers and unexpected approaches in candidates' scripts must be given marks that fairly reflect the relevant knowledge and skills demonstrated.













Mark schemes should be read in conjunction with the published question papers and the report on the examination.

OCR will not enter into any discussion or correspondence in connection with this mark scheme.

© OCR 2013

Annotations

Annotations available in Scoris.

Annotation	Meaning
	Benefit of doubt given
	Contradiction
	Incorrect response
	Error carried forward
	Ignore
	Not answered question
	Benefit of doubt not given
	Power of 10 error
	Omission mark
	Rounding error
	Error in number of significant figures
	Correct response

Abbreviations, annotations and conventions used in the detailed Mark Scheme (to include abbreviations and subject-specific conventions).

Annotation	Meaning
DO NOT ALLOW	Answers which are not worthy of credit
IGNORE	Statements which are irrelevant
ALLOW	Answers that can be accepted
()	Words which are not essential to gain credit
—	Underlined words must be present in answer to score a mark
ECF	Error carried forward
AW	Alternative wording
ORA	Or reverse argument

Generic comments

ORGANIC STRUCTURES

For a 'structure' or 'structural formula',

- **ALLOW** correct structural **OR** displayed **OR** skeletal formula **OR** mixture of the above (as long as unambiguous)

For an alkyl group shown within a structure,

- **ALLOW** bond drawn to C or H,
eg **ALLOW** CH₃–, CH₂–, C₃H₇–, etc
- **ALLOW** vertical 'bond' to any part of an alkyl group

For an OH group shown within a structure,

- **DO NOT ALLOW** formula with horizontal —HO **OR** OH—
- **ALLOW** vertical 'bond' to any part of the OH group

For a CHO group shown within a structure,

- **DO NOT ALLOW** COH

For a 3D structure,

• For bond in the plane of paper, a solid line is expected:	
• For bond out of plane of paper, a solid wedge is expected:	
• For bond into plane of paper, ALLOW :	
• ALLOW a hollow wedge for 'in bond' OR an 'out bond', provided it is different from the other in or out wedge eg:	

NAMES

Names including alkyl groups:

- **ALLOW** alkanyl, eg ethanyl (ie **IGNORE** 'an')
- **DO NOT ALLOW** alkol, eg ethol (ie 'an' is essential)

Names of esters:

- Two words are expected, eg ethyl ethanoate
- **ALLOW** one word, eg ethylethanoate

Names with multiple numbers and hyphens:

Use of 'e'

- **ALLOW** superfluous 'e', eg propane-1-ol ('e' is kept if followed by consonant)
- **ALLOW** absence of 'e', eg propan-1,2-diol ('e' is omitted if followed by vowel)

Hyphens separate name from numbers:

- **ALLOW** absence of hyphens, eg propane 1,2 diol

Multiple locant numbers must be clearly separated:

- **ALLOW** full stops: eg 1.2 **OR** spaces: 1 2
- **DO NOT ALLOW** eg 12

Locant numbers in formula must be correct

- **DO NOT ALLOW** propan-3-ol

Order of substituents should be alphabetical:

- **ALLOW** any order (as long as unambiguous), eg 2-chloro-3-bromobutane

ABBREVIATIONS

van der Waal's forces

ALLOW vdw forces **OR** VDW forces (and any combination of upper and lower cases)

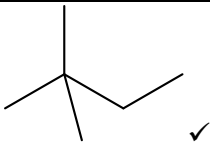
Question		Answer	Marks	Guidance
1	(a)	C_3H_7 ✓	1	ALLOW H_7C_3
	(b)	<p>Saturated Only has (carbon to carbon) single bonds ✓</p> <p>Hydrocarbon Contains (the elements) hydrogen and carbon only ✓</p>	2	<p>ALLOW does not contain any (carbon to carbon) double bonds ALLOW all of the carbon atoms are bonded to four other atoms</p> <p>DO NOT ALLOW contains hydrogen and carbon DO NOT ALLOW a mixture of carbon and hydrogen only DO NOT ALLOW hydrogen and carbon molecules only</p>
	(c)		1	
	(d)	<p>as branching increases the boiling point decreases OR the more branched the isomers of hexane are the lower the boiling point ✓</p> <p>branched isomers have less surface (area) of contact OR branched fewer points of contact (than unbranched) ✓</p> <p>(the more branched the) fewer van der Waals' forces OR (the more branched) has weaker van der Waals' forces OR Less energy required to break van der Waal's forces ✓</p>	3	<p>ALLOW ORA throughout <i>First marking point must compare boiling point and branching for all three isomers</i></p> <p>Reference to just surface area / closeness of molecules is not sufficient</p> <p>ALLOW vdw forces OR VDW forces (and any combination of upper and lower cases) DO NOT ALLOW VDW mark if answer states that these are between atoms or answer implies that these are bonds</p>
	(e)	<p>$C_{10}H_{22} \rightarrow C_6H_{14} + C_4H_8$ OR $C_{10}H_{22} \rightarrow C_6H_{14} + 2C_2H_4$ ✓</p>	1	<p>ALLOW correct structural OR displayed OR skeletal formula OR mixture of the above (as long as unambiguous) IGNORE state symbols</p>

Question		Answer	Marks	Guidance						
1	(f)	(i) $C_4H_{10} + 2Cl_2 \rightarrow C_4H_8Cl_2 + 2HCl$ ✓	1	IGNORE state symbols						
		(ii) <table border="1" style="width: 100%; border-collapse: collapse;"> <thead> <tr> <th style="width: 50%;">Isomer 1</th> <th style="width: 50%;">Isomer 2</th> </tr> </thead> <tbody> <tr> <td></td> <td>1,3-dichlorobutane ✓</td> </tr> <tr> <td> Correct displayed formula eg: <pre style="font-family: monospace; font-size: 0.8em;"> H H H H Cl-C-C-C-C-Cl H H H H ✓ </pre> </td> <td></td> </tr> </tbody> </table>	Isomer 1	Isomer 2		1,3-dichlorobutane ✓	Correct displayed formula eg: <pre style="font-family: monospace; font-size: 0.8em;"> H H H H Cl-C-C-C-C-Cl H H H H ✓ </pre>		2	Must be a displayed formula ALLOW absence of hyphens 1 and 3 must be clearly separated: ALLOW full stops: 1.3 OR spaces: 1 3 DO NOT ALLOW 13
Isomer 1	Isomer 2									
	1,3-dichlorobutane ✓									
Correct displayed formula eg: <pre style="font-family: monospace; font-size: 0.8em;"> H H H H Cl-C-C-C-C-Cl H H H H ✓ </pre>										
	(g)	(i) covalent bond breaking ✓ one electron (from the bond pair) goes to each atom OR makes (two) radicals ✓	2	ALLOW covalent bond is split IGNORE particle for atom DO NOT ALLOW molecule or compound for atom DO NOT ALLOW to each molecule or to each reactant ALLOW one electron goes to each product / species IGNORE homolytic fission equations						
		(ii) $Cl + C_4H_9Cl \rightarrow C_4H_8Cl + HCl$ ✓ $C_4H_8Cl + Cl_2 \rightarrow C_4H_8Cl_2 + Cl$ ✓	2	IGNORE dots even if incorrect						
	(h)	$C_4H_{10} + 4\frac{1}{2}O_2 \rightarrow 4CO + 5H_2O$ OR $C_4H_{10} + 2\frac{1}{2}O_2 \rightarrow 4C + 5H_2O$ ✓	1	ALLOW any correct multiples for these equations eg $2C_4H_{10} + 9O_2 \rightarrow 8CO + 10H_2O$ IGNORE state symbols ALLOW equations for incomplete combustion that give CO_2 with CO and/or C eg $C_4H_{10} + 4O_2 \rightarrow 3CO + C + 5H_2O$						
Total			16							

Question		Answer	Marks	Guidance
2	(a)	(enthalpy change for the) formation of one mole (of P_4O_{10}) ✓ from (constituent) elements OR from P_4 /phosphorus and O_2 /oxygen ✓	2	ALLOW energy required OR energy released ALLOW makes one mole of product/substance/molecule/compound ALLOW made from P and O_2 OR made from two elements IGNORE comments related to standard conditions
	(b)	FIRST, CHECK THE ANSWER ON ANSWER LINE IF answer = $-368 \text{ (kJ mol}^{-1}\text{)}$ award 3 marks (+)2984 +(+)6 × 286 OR (+)2984 +(+)1716 OR (+)4700 ✓ (-)1267 × 4 OR (-)5068 ✓ -368 ✓	3	IF there is an alternative answer, check to see if there is any ECF credit possible using working below. See list below for marking of answers from common errors. IGNORE sign IGNORE sign ALLOW ECF for enthalpy change of products – enthalpy change of reactants ALLOW for 2 marks: +368 cycle wrong way around OR -1798 no × 6 OR (+)3433 no × 4 OR -3352 missing 2984 OR (+) 9768 product the wrong sign around OR (-) 9768 reactants the wrong sign ALLOW for 1 mark: (+)1798 no × 6 and cycle wrong way around OR -3433 cycle wrong way around and not × 4 OR (+)3352 missing 2984 and cycle wrong way around OR (+)2003 no × 6 or × 4 OR (+)449 missing 2984 and × 4 OR -4782 missing 2984 and × 6 Note: There may be other possibilities.

Question		Answer	Marks	Guidance
	(c)	$P_4 + 5O_2 + 6H_2O \rightarrow 4H_3PO_4$ ✓ Only the desired product is made ✓ Second marking point can only be awarded if the equation is correct.	2	ALLOW there are no waste products OR there are no by-products OR there is only one product. DO NOT ALLOW it is an addition reaction
			Total	7

Question			Answer	Marks	Guidance
3	(a)	(i)	acid ✓	1	ALLOW named mineral acid or correct formula eg phosphoric acid, H ₃ PO ₄ , sulfuric acid, H ₂ SO ₄ or H ⁺ DO NOT ALLOW any carboxylic acids
		(ii)	C ₅ H ₁₂ O → C ₅ H ₁₀ + H ₂ O ✓	1	DO NOT ALLOW use of C ₅ H ₁₁ OH
		(iii)	structural isomerism have the same molecular formula ✓ but different structural formulae ✓ stereoisomerism have the same structural formula ✓ but different arrangement (of atoms) in space ✓	4	Same formula is not sufficient ALLOW different structure OR different displayed formula OR different skeletal formula Different formula or different arrangement of atoms is not sufficient ALLOW different structural arrangement (of atoms) ALLOW have the same structure Stereoisomers have the same formula or molecular formula is not sufficient ALLOW different spatial arrangements (of atoms)

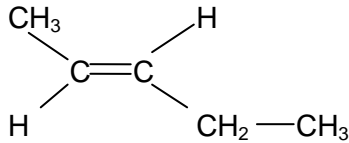
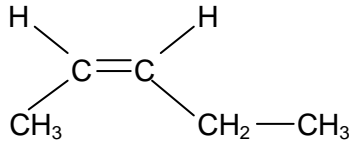
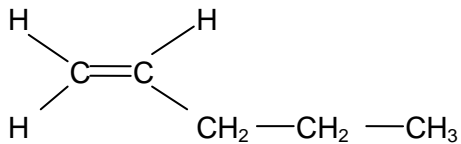
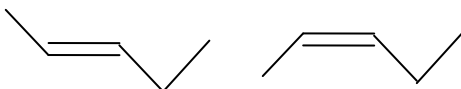
Question			Answer	Marks	Guidance
3	(a)	(iv)	<div style="text-align: center;">  <p>A</p> </div> <div style="text-align: center;">  <p>B</p> </div> <div style="text-align: center;">  <p>C</p> </div> <p>Correct structure for A ✓</p> <p>Correct structure for B ✓</p> <p>Correct structure for C ✓</p>	3	<p>ALLOW correct structural OR displayed OR skeletal formula OR mixture of the above</p> <p>A and B must clearly show cis and trans configuration</p> <p>eg</p> <div style="text-align: center;">  <p>A B</p> </div> <p>Answers to A and B are interchangeable</p> <p>C: CH₂CHCH₂CH₂CH₃</p> <p>ALLOW -C₂H₅ group in A or B or -CH₂C₂H₅ in C DO NOT ALLOW -C₃H₇ group in C</p>

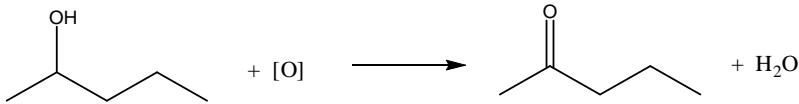
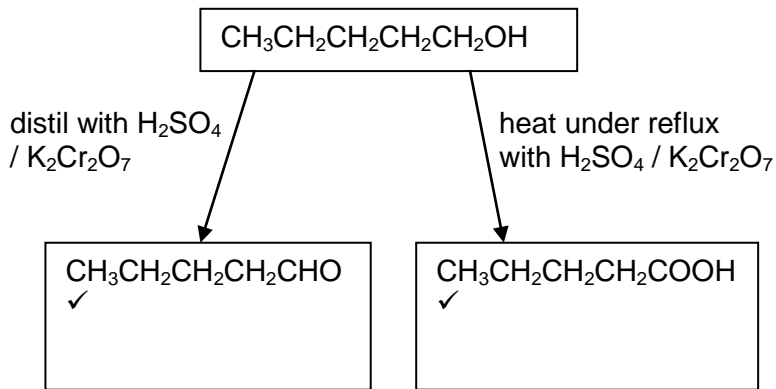
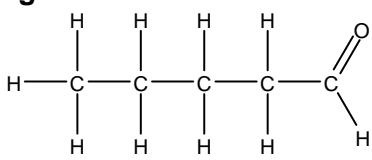
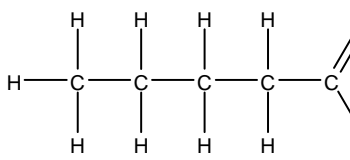
Question		Answer	Marks	Guidance
3	(a) (v)	carbon-carbon double bond ✓ Each carbon atom in the double bond is attached to (two) different groups/atoms ✓	2	IGNORE comments about rotation ALLOW carbon double bond ALLOW Each carbon atom of the double bond is attached to a H and an alkyl group DO NOT ALLOW functional groups for groups DO NOT ALLOW the carbon atoms are attached to different groups “Each carbon atom in the double bond” implies a carbon-carbon double bond for the first marking point
	(b)	 Correct skeletal structure of product ✓ Balanced equation ✓	2	Balancing mark can only be awarded if the equation has a correct skeletal formula for the product
	(c)		2	ALLOW correct structural OR displayed OR skeletal formula OR mixture of the above (as long as unambiguous) eg   ALLOW CO ₂ H for the carboxylic acid DO NOT ALLOW COH for aldehyde IGNORE names
Total			15	

Question	Answer	Marks	Guidance
4 (a)	<p>FIRST, CHECK THE ANSWER ON ANSWER LINE IF answer = 681 (kJ) award 3 marks</p> <p>Evidence of dividing 1000 by 24</p> <p>Evidence of dividing by 3 and multiplying by 49 in the calculation</p> <p>energy released = 681 (kJ) ✓</p> <p>(MUST BE TO 3 SIG FIGS)</p> <p>-----</p> <p>Alternative Working</p> <p>3 moles = 72 dm³ ✓</p> <p>So $\frac{1000}{72}$ or 13.9 ✓</p> <p>Energy released = 13.9 × 49 = 681 (kJ)</p>	3	<p>IF there is an alternative answer, check to see if there is any ECF credit possible using working below.</p> <p>ALLOW 41.7 up to calculator value 41.6666667 correctly rounded.</p> <p>ALLOW $\frac{1000}{24}$ for first marking point if not calculated</p> <p>ALLOW energy released per mole = 16.3 ✓</p> <p>IGNORE (-) sign in the answer</p> <p>Common Incorrect answers 0.392 scores 2 marks 392000 scores 2 marks</p>

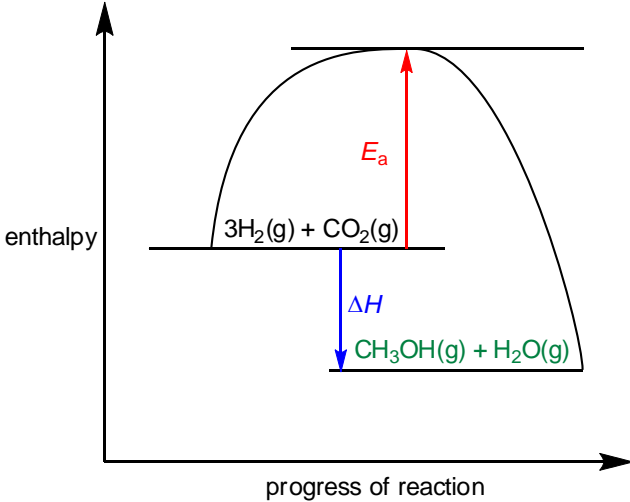
Question	Answer	Marks	Guidance
<p>4 (b)</p>	 <p>CH₃OH and H₂O added as product AND shown below the reactants ✓</p> <p>ΔH labelled with arrow pointing towards products or the product line if no products stated ✓</p> <p>E_a labelled correctly AND above reactants ✓</p>	<p>3</p>	<p>IGNORE state symbols for the products</p> <p>IF there is no ΔH labelled then ALLOW -49 only as an alternative label for ΔH IF ΔH is labelled then IGNORE any numerical value DO NOT ALLOW -ΔH ALLOW this arrow even if it has a small gap at the top and bottom i.e. does not quite reach reactant or product line</p> <p>ALLOW (+) 225 only as an alternative label for E_a ALLOW arrows at both ends of activation energy line The E_a line must point to maximum (or near to the maximum) on the curve ALLOW this line even if it has a small gap at the top and bottom ie does not quite reach the maximum or reactant line ALLOW A_E or E_a for activation energy</p>

Question		Answer	Marks	Guidance
	(c)	(+)49 ✓	1	DO NOT ALLOW -49
	(d)	(+)274 ✓	1	DO NOT ALLOW -274 ALLOW answer to (c) + 225 as ECF
	(e)	(equilibrium position shifts) to the left ✓ (Forward) reaction is exothermic OR reaction gives out heat OR reverse reaction is endothermic OR reverse reaction takes in heat ✓ The explanation mark is dependent on the correct shift of the equilibrium	2	ALLOW 'favours the left', as alternative for 'shifts equilibrium to left' Note: ALLOW suitable alternatives for 'to left', eg: towards CO ₂ / H ₂ OR towards reactants OR in backward direction OR in reverse direction OR decreases yield of CH ₃ OH /products IGNORE responses in terms of rate
	(f)	(equilibrium position) shifts to the left ✓ Right-hand side has fewer (gaseous) moles/molecules ✓ ORA The explanation mark is dependent on the correct shift of the equilibrium	2	ALLOW 'favours the left', as alternative for 'shifts equilibrium to left' Note: ALLOW suitable alternatives for 'to left', eg: towards CO ₂ / H ₂ OR towards reactants OR in backward direction OR in reverse direction OR decreases yield of CH ₃ OH /products IGNORE responses in terms of rate ALLOW four moles on the left and two moles on the right ALLOW more moles of reactants or fewer moles of products ASSUME "goes the side with more gas molecules" implies from equation that more molecules on the left OR "goes to side with fewer gas molecules" implies from equation that fewer molecules are on the right

Question		Answer	Marks	Guidance
	(g)	<p>Adsorption of reactants OR adsorption of gases OR H₂ and CO₂ attached to surface ✓</p> <p>Bonds weaken in reactants OR chemical reaction OR activation energy decreases ✓</p> <p>Desorption of products OR desorption of H₂O and CH₃OH ✓</p>	3	<p>ALLOW CO₂ and H₂ (weakly) bonded to surface OR reactants bond to surface OR CO₂ and H₂ form temporary bonds with the catalyst DO NOT ALLOW absorption</p> <p>ALLOW bonds weaken in H₂ OR bonds weaken in CO₂ OR C=O bonds weaken OR bonds break and new bonds made in product OR H₂O and CH₃OH made</p> <p>ALLOW products leave the surface/catalyst OR H₂O and CH₃OH no longer bonded to surface/catalyst ALLOW desorption OR adsorb from for desorption ALLOW diffuse away for desorption</p>
Total			15	

Question	Answer	Marks	Guidance
5 (a)	<p>FIRST, CHECK THE ANSWER ON ANSWER LINE IF answer = 90% award 3 marks</p> <p>amount of dichloroethane = $\frac{19800000}{99.0}$</p> <p>OR 200000 (mol) OR 2×10^5 (mol) ✓</p> <p>amount of chloroethene = $\frac{11250000}{62.5}$</p> <p>OR 180000 (mol) OR 1.8×10^5 (mol) ✓</p> <p>Calculates percentage yield = $\frac{180000}{200000} \times 100 = 90\%$ ✓</p>	3	<p>IF there is an alternative answer, check to see if there is any ECF credit possible using working below.</p> <p>ALLOW approach based on mass for 2nd and 3rd marks</p> <p>Theoretical mass of chloroethene = 200000×62.5 OR 12500000 (g) OR 1.25×10^7 (g) ✓</p> <p>Calculates percentage yield = $\frac{11250000}{12500000} \times 100 = 90\%$ ✓</p> <hr/> <p>ALLOW approach based on grams rather than tonnes:</p> <p>$n(\text{dichloroethane}) = \frac{19.80}{99.0}$ OR 0.2 (mol) ✓</p> <p>$n(\text{chloroethane}) = \frac{11.25}{62.5}$ OR 0.18 (mol)</p> <p>OR theoretical mass chloroethane = 0.2×62.5 OR 12.5 g ✓</p> <p>% yield = $\frac{0.18}{0.20} \times 100 = 90\%$ OR $\frac{11.25}{12.5} \times 100 = 90\%$ ✓</p> <hr/> <p>ALLOW ECF throughout from wrong M_r value(s) with final % yield to 2 or more significant figures DO NOT ALLOW final mark for an answer above 100%</p> <hr/> <p>Note: If this is the only working seen award no marks</p> <p>ie $\frac{11.25 \times 10^6}{19.80 \times 10^6} \times 100 = 56.81\%$</p>

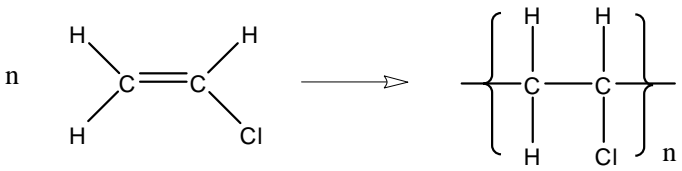
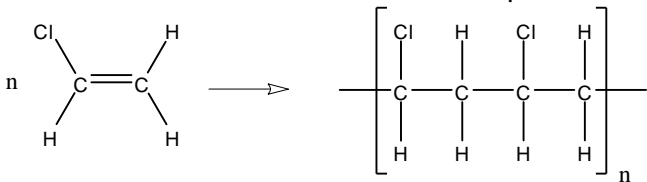
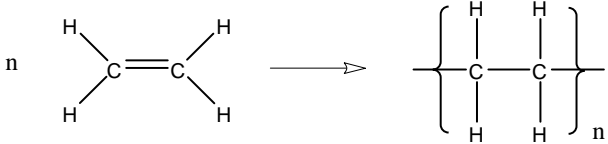
Question	Answer	Marks	Guidance
<p>5 (b)</p>	<p>FIRST, CHECK THE ANSWER ON ANSWER LINE IF answer = (+)62 award 3 marks</p> <p>ΔH for bonds broken = 2691 (kJ mol⁻¹) ✓</p> <p>ΔH for bond formed = 2629 (kJ mol⁻¹) ✓</p> <p>$\Delta H = (+)62$ (kJ mol⁻¹) ✓</p>	<p>3</p>	<p>IF there is an alternative answer, check to see if there is any ECF credit possible.</p> <p>IGNORE sign ALLOW 1106 (C–Cl, C–C and C–H bonds)</p> <p>IGNORE sign ALLOW 1044 (H–Cl and C=C bonds)</p> <p>ECF based on bonds broken – bonds formed</p> <p>ALLOW 2 marks for –62</p>
<p>(c)</p>	<p>Displayed formulae of monomer and polymer required for the marks.</p>  <p>Only chloroethene on left hand side ✓</p> <p>Only the correct polymer on right hand side ✓</p> <p>A correctly balanced equation using displayed formulae for any monomer and matching polymer including the correct use of n ✓</p>	<p>3</p>	<p>Polymer must have side links (do not have to cut through bracket and can be dotted lines)</p> <p>ALLOW a correct section of the polymer with side links as below would score two marks as the equation is not balanced</p>  <p>DO NOT ALLOW ECF from wrong monomer</p> <p>n on LHS can be at any height to the left of formula AND n on the RHS must be a subscript (essentially below the side link)</p> <p>The equation below would be worth 1 mark for balancing</p> 

Question		Answer	Marks	Guidance
	(d) (i)	React with an alkali OR react with a base/carbonate OR Bubble through water (to make HCl(aq)) OR dissolve in water ✓	1	ALLOW react with a named alkali or base eg calcium carbonate, calcium hydroxide, magnesium oxide, ammonia ALLOW an appropriate chemical formula IGNORE use of gas scrubbers
	(ii)	Sort and recycle ✓ Organic feedstock OR cracked ✓	2	ALLOW separate and recycle or sorting and remoulding ALLOW use for the production organic compounds OR synthesis gas ALLOW the production of plastics or monomers or new polymers
	(iii)	(Bio) degradable (polymers) OR compostable (polymers) OR soluble (polymers) OR photodegradable (polymers) ✓	1	IGNORE a named polymer if degradable DO NOT ALLOW any addition polymer eg PTFE
		Total	13	

Question		Answer	Marks	Guidance
6	(a)	<p>Bond breaking absorbs energy AND bond forming releases energy ✓</p> <p>More energy released than absorbed ✓</p> <p>The second marking point is dependent on the correct identification of the energy changes during bond breaking and bond making</p>	2	<p>ALLOW bond breaking is endothermic AND bond forming is exothermic</p> <p>DO NOT ALLOW bond forming requires energy</p> <p>ALLOW more energy is released when the bond in the products are formed than is required to break the bonds in the reactants</p> <p>ALLOW exothermic change transfers more energy than endothermic change</p> <p>OR bond forming transfers more energy than bond breaking</p> <p>OR '(the sum of the) bond enthalpies in the products is greater than the (sum of the) bond enthalpies in the reactants'</p> <p>OR '(the sum of the) bond enthalpies of the bonds made is greater than (the sum of) the bond enthalpies of the bonds broken'</p> <p>OR more energy associated with bond making than with bond breaking</p> <p>IGNORE reference to strong and weak bonds</p> <p>IGNORE reference to number of bonds broken or made</p> <p>IGNORE enthalpy of products is less than enthalpy of reactants</p>
	(b) (i)	<p>(C=O) bond vibrates (more)</p> <p>OR bond bends (more)</p> <p>OR bond stretches (more) ✓</p>	1	<p>IGNORE molecule vibrates/rotates</p> <p>"It" refers to the molecule and is insufficient</p> <p>DO NOT ALLOW any reference to bond breaking.</p> <p>DO NOT ALLOW a stated bond if not present in CO₂ eg C–O, C–H</p>

Question	Answer	Marks	Guidance
	<p>(ii) Any two from: (injected) deep into the oceans / sea ✓</p> <p>(Stored) in geological formations OR (stored) deep in rocks OR (stored) in old mines OR (stored) in old oil wells OR old gas fields ✓</p> <p>(Stored) by reaction with metal oxides OR reaction to form (solid) carbonates OR (stored) as a carbonate OR equation to show formation of metal carbonate ✓</p>	2	<p>DO NOT ALLOW reference to carbon being stored – the answer must either refer to carbon dioxide or not mention the name of the stored substance. Assume “it” refers to CO₂</p> <p>DO NOT ALLOW dumping waste at the bottom of the sea</p> <p>ALLOW on the sea-bed</p> <p>DO NOT ALLOW dissolve CO₂ in the sea OR (stored) in ocean</p> <p>DO NOT ALLOW geographical formations ALLOW stored under the sea (bed) ALLOW pumped into oil wells to force last bit of oil out DO NOT ALLOW buried underground</p> <p>DO NOT ALLOW react with metals to form carbonates</p> <p>IGNORE mineral storage</p>

Question	Answer	Marks	Guidance
(c)	<p>Any two from:</p> <p>Energy demand Low(er) temperature (can be used) OR reduces CO₂ emissions (from burning fossil fuels) ✓</p> <p>Specificity enzymes have a great deal of specificity ✓</p> <p>Atom economy greater atom economy OR less waste ✓</p> <p>Toxicity can reduce use of toxic solvents OR reduces use of toxic catalysts OR reduces the use of toxic reactants ✓</p>	2	<p>ALLOW 'allows use of room temperature' OR 'allows use of a lower pressure' OR uses less fuel</p> <p>IGNORE lower energy demand OR lower activation energy IGNORE cheaper IGNORE less greenhouse gases OR reduces global warming</p> <p>ALLOW making specific isomers / enantiomers ALLOW for making pure products ALLOW generating specified products</p> <p>ALLOW increases atom economy</p> <p>ALLOW reduce use of hazardous/toxic/harmful/poisonous chemicals ALLOW enzymes are non toxic IGNORE can be reused</p>

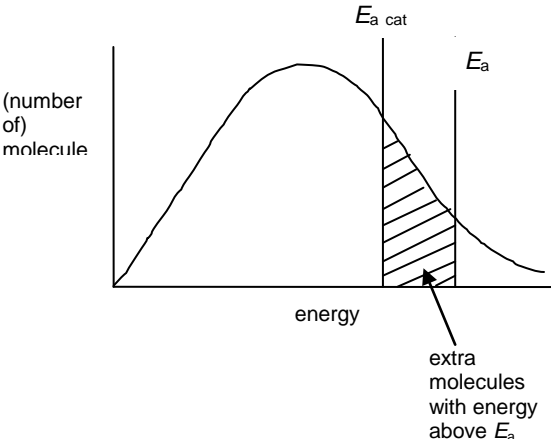
Question	Answer	Marks	Guidance
(d)	<p>Catalyst lowers the activation energy (because of a different reaction pathway) ✓</p> <p>Diagram of Boltzmann distribution ✓</p> <p>axes labelled (number of) molecules and energy ✓</p>  <p>Greater proportion of molecules with energy above activation energy with catalyst ✓</p> <p>more effective collisions OR more successful collisions OR increased frequency of successful collisions ✓</p>	5	<p>Can be scored from the diagram by correctly labelling $E_{a\ cat}$ closer to the origin than E_a</p> <p>Boltzmann distribution must start at origin AND must not touch x-axis at high energy</p> <p>DO NOT ALLOW Boltzmann distribution mark if two curves drawn</p> <p>DO NOT ALLOW Boltzmann distribution curve bending upwards at higher energy</p> <p>ALLOW particles instead of molecules</p> <p>DO NOT ALLOW the first use of atoms but credit atoms if used in a subsequent marking point</p> <p>DO NOT ALLOW enthalpy on x-axis instead of energy</p> <p>ALLOW more molecules with energy above activation energy (with a catalyst)</p> <p>OR more molecules overcome the activation energy (with a catalyst)</p> <p>OR more molecules have enough energy to react (with a catalyst)</p> <p>OR more molecules are able to react at lower energies</p> <p>More collisions OR more frequent collisions are not sufficient</p>
	Total	12	

Question	Answer	Marks	Guidance
7	<p>Nucleophilic substitution reaction</p> <p>correct equation for the reaction ✓ $\text{CH}_2\text{CHCH}_2\text{CH}_2\text{Cl} + \text{KOH} \rightarrow \text{CH}_2\text{CHCH}_2\text{CH}_2\text{OH} + \text{KCl}$</p> <p>OR $\text{C}_4\text{H}_7\text{Cl} + \text{KOH} \rightarrow \text{C}_4\text{H}_7\text{OH} + \text{KCl}$</p> <p>correct product of the reaction ✓</p> <div data-bbox="371 580 831 783" style="border: 1px solid black; padding: 5px; width: fit-content; margin: 10px auto;"> </div> <p>Mechanism</p> <div data-bbox="365 895 1137 1114" style="text-align: center;"> </div> <p>dipole shown on C—Cl bond: $\text{C}^{\delta+}$ and $\text{Cl}^{\delta-}$ in the correct chloroalkene ✓</p> <p>curly arrow from HO^- to carbon atom of C—Cl bond AND curly arrow from C—Cl bond to chlorine atom ✓</p> <p>formation of Cl^- ✓</p>	5	<p>ANNOTATE ANSWER WITH TICKS AND CROSSES ETC</p> <p>ALLOW $\text{CH}_2\text{CHCH}_2\text{CH}_2\text{Cl} + \text{OH}^- \rightarrow \text{CH}_2\text{CHCH}_2\text{CH}_2\text{OH} + \text{Cl}^-$</p> <p>ALLOW $\text{C}_4\text{H}_7\text{Cl} + \text{OH}^- \rightarrow \text{C}_4\text{H}_7\text{OH} + \text{Cl}^-$</p> <p>ALLOW correct molecular OR structural OR displayed OR skeletal formula OR mixture of the above</p> <p>For structure of the product ALLOW correct structural OR displayed OR skeletal formula OR mixture of the above (as long as unambiguous) if seen ONCE in equation, mechanism or drawn out eg $\text{CH}_2\text{CHCH}_2\text{CH}_2\text{OH}$</p> <p>curly arrow must start from one lone pair on O atom of OH^- OR from negative charge on the O atom of the OH^- ion</p> <p>Lone pair does not need to be shown on OH^- ion</p>

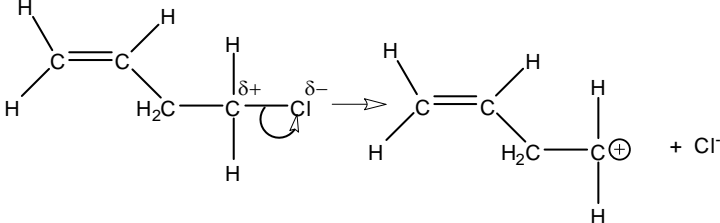
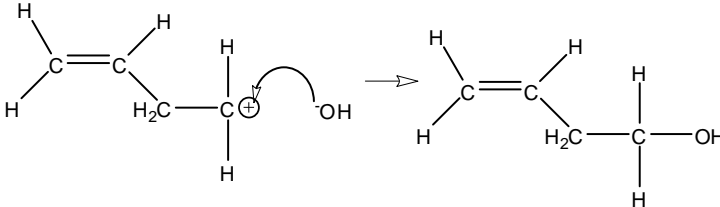
Question	Answer	Marks	Guidance
	<p>Nucleophilic substitution continued (S_N1)</p> <p>Step 1:</p>  <p>Step 2:</p> 		<p>ANNOTATE ANSWER WITH TICKS AND CROSSES ETC</p> <p>ALLOW S_N1 mechanism</p> <p>dipole shown on C–Cl bond, C^{δ+} and Cl^{δ-} in correct chloroalkene ✓</p> <p>curly arrow from C–Cl bond to halogen atom and Cl⁻ ✓</p> <p>curly arrow from ⁻OH to correct carbocation ✓</p> <p>curly arrow must start from one lone pair on O atom of ⁻OH ion</p> <p>OR from negative charge on the O atom of the ⁻OH ion</p> <p>Lone pair does not need to be shown on ⁻OH ion</p>

Question	Answer	Marks	Guidance
7	<p>Electrophilic addition</p> <p>correct equation for the reaction ✓</p> $\text{CH}_2\text{CHCH}_2\text{CH}_2\text{Cl} + \text{HBr} \longrightarrow \text{CH}_3\text{CHBrCH}_2\text{CH}_2\text{Cl}$ <p>OR</p> $\text{CH}_2\text{CHCH}_2\text{CH}_2\text{Cl} + \text{HBr} \longrightarrow \text{CH}_2\text{BrCH}_2\text{CH}_2\text{CH}_2\text{Cl}$ <p>Indication that there are two possible addition products ✓</p> <p>Correct product ✓</p> <div style="display: flex; align-items: center; justify-content: center;"> <div style="border: 1px solid black; padding: 5px; margin-right: 10px;"> $\begin{array}{cccc} \text{H} & \text{Br} & \text{H} & \text{H} \\ & & & \\ \text{H}-\text{C} & -\text{C} & -\text{C} & -\text{C}-\text{Cl} \\ & & & \\ \text{H} & \text{H} & \text{H} & \text{H} \end{array}$ </div> <div style="margin-right: 10px;">OR</div> <div style="border: 1px solid black; padding: 5px;"> $\begin{array}{cccc} \text{Br} & \text{H} & \text{H} & \text{H} \\ & & & \\ \text{H}-\text{C} & -\text{C} & -\text{C} & -\text{C}-\text{Cl} \\ & & & \\ \text{H} & \text{H} & \text{H} & \text{H} \end{array}$ </div> </div> <p>Mechanism</p> <p>Curly arrow from C=C of correct chloroalkene to attack the H atom in HBr ✓</p> <p>Correct dipole on H-Br: H^{δ+} and Br^{δ-} AND curly arrow from H-Br bond to Br ✓</p> <p>Correct carbocation / carbonium ion with the full positive charge shown: C⁺ AND correct curly arrow from lone pair of Br⁻ to correct carbon atom OR correct curly arrow from negative charge of Br⁻ to correct carbon atom ✓</p>	6	<p>ANNOTATE ANSWER WITH TICKS AND CROSSES ETC</p> <p>ALLOW correct molecular OR structural OR displayed OR skeletal formula OR mixture of the above.</p> <p>eg C₄H₇Cl + HBr → C₄H₈BrCl</p> <p>For the structure of the product ALLOW correct structural OR displayed OR skeletal formula OR mixture of the above (as long as unambiguous) if seen ONCE in equation, mechanism or drawn out eg CH₂BrCH₂CH₂CH₂Cl or CH₃CHBrCH₂CH₂Cl</p> <p>curly arrow must start from covalent bonds and not atoms Lone pair does not need to be shown on ion or used in mechanism</p> <p>DO NOT ALLOW any other partial charges eg shown on double bond</p> <p>DO NOT ALLOW C^{δ+} for charge on carbonium ion.</p> <p>Curly arrow from Br⁻ can start from the negative charge or the lone pair DO NOT ALLOW delta negative, i.e. Br^{δ-}</p>

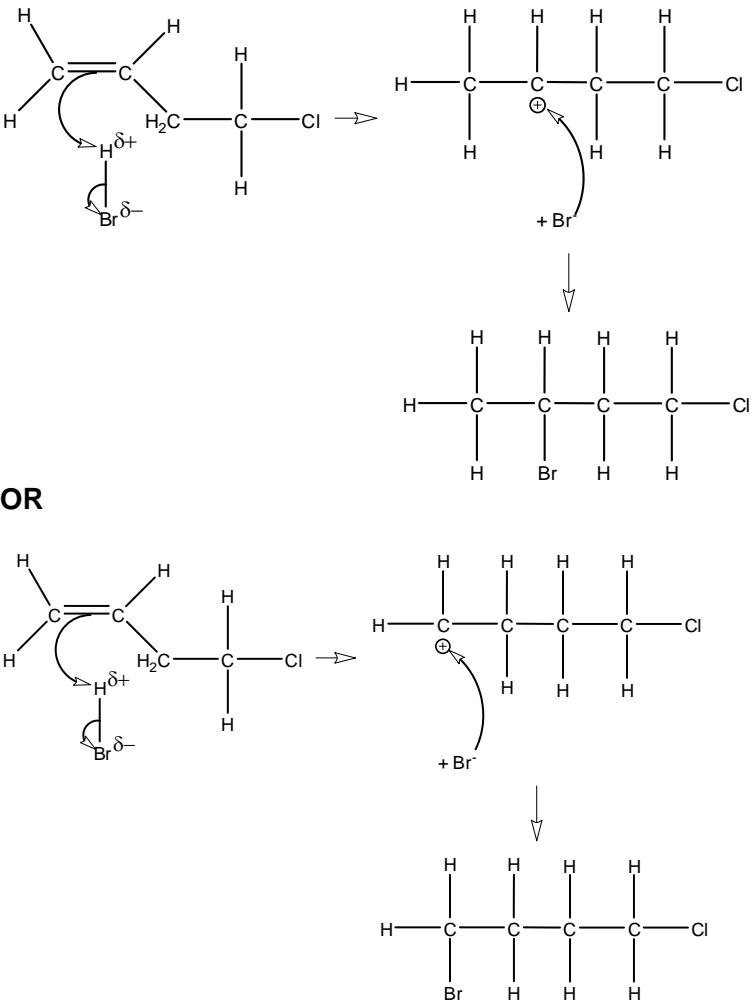
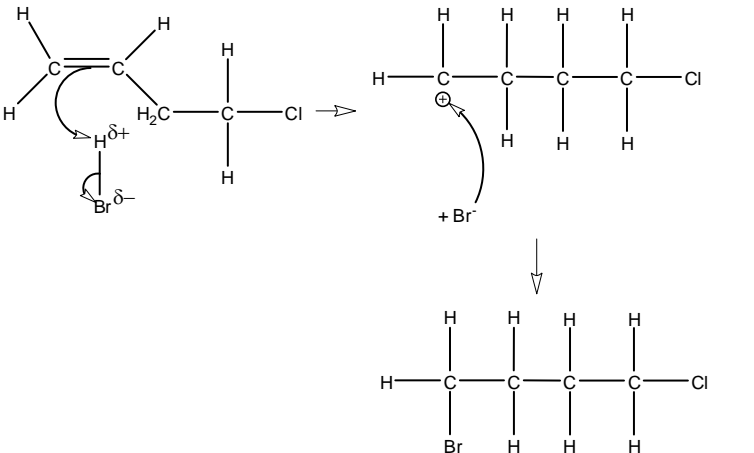
Question	Answer	Marks	Guidance
7	<p>Electrophilic addition continued</p>  <p>OR</p> 	1	
	<p>heterolytic fission for both mechanisms and not contradicted ✓</p>		

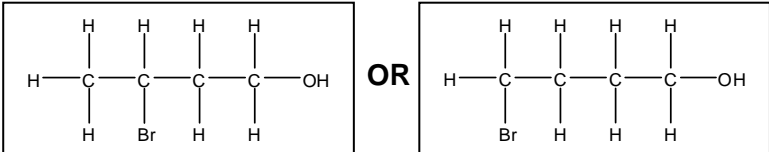
Question	Answer	Marks	Guidance
	<p>ALTERNATIVE APPROACH The Candidate who reacts with KOH followed by HBr</p> <ul style="list-style-type: none"> Award all marks for the nucleophilic substitution mechanism as per the marking scheme You can award all marks for the electrophilic addition mechanism; however the product will be one of the following: <div style="text-align: center;">  <p>The image shows two structural diagrams of bromobutane isomers. The first diagram shows 1-bromobutane with a bromine atom on the first carbon. The second diagram shows 2-bromobutane with a bromine atom on the second carbon. The two diagrams are separated by the word 'OR'.</p> </div> <ul style="list-style-type: none"> The mechanism will be the same except the $-Cl$ will now be replaced by $-OH$ at every stage 		
	Total	12	

Question	Answer	Marks	Guidance
8	<p>IR spectrum</p> <p>(absorbance between) 3200–3550 cm⁻¹ indicates –OH AND X is an alcohol ✓</p>	1	<p>LOOK ON THE SPECTRUM for labelled absorbance which can be given credit ALLOW an absorbance within the range 3100 to 3700cm⁻¹ from the spectrum. Answer must give –OH and alcohol for the mark.</p> <p>IGNORE phenol DO NOT ALLOW carboxylic acid (there is no carbonyl group present in the spectrum)</p>
	<p>Formula</p> <p>mole ratio C : H : O</p> <p>$\frac{0.600}{12} : \frac{0.133}{1.0} : \frac{0.267}{16}$ OR 0.0500 : 0.133 : 0.0167 ✓</p> <p>$\frac{0.05}{0.0167} : \frac{0.133}{0.0167} : \frac{0.0167}{0.0167}$ OR 3 : 8 : 1 OR C₃H₈O ✓</p> <p>Candidate links C₃H₈O to 60 such as C₃H₈O has <i>M_r</i> 60 OR C₃H₈O has <i>m/z</i> = 60 ✓</p>	3	<p>Must be a clear link between the formula and the <i>M_r</i> OR <i>m/z</i> ALLOW evidence of <i>M_r</i>, eg (12 × 3) + (8 × 1) + 16; 36 + 8 + 16 = 60</p> <p>ALLOW alternative approach for empirical formula and evidence that 60 is equal to C₃H₈O</p> <p><i>M_r</i> = 60</p> <p>Carbon Hydrogen $60 \times \frac{60}{100} = 36$ $60 \times \frac{13.3}{100} = 8$</p> <p>36/12 = 3 C 8/1 = 8H</p> <p>36 + 8 = 44 60 – 44 = 16 so 1 O C₃H₈O</p>

Question	Answer	Marks	Guidance
8	<p>Identification and equation</p> <p>X is $\text{CH}_3\text{CH}_2\text{CH}_2\text{OH}$ OR $\text{CH}_3\text{CHOHCH}_3$ OR either $\text{CH}_3\text{CH}_2\text{CH}_2\text{OH}$ or $\text{CH}_3\text{CHOHCH}_3$ ✓</p> <p>QWC Stated in words that Y must be an ester because it is made from the reaction of a carboxylic acid AND X (propan-1-ol OR propan-2-ol OR an alcohol) ✓</p> <p>Y is $\text{CH}_3\text{COOCH}_2\text{CH}_2\text{CH}_3$ OR $\text{CH}_3\text{COOCH}(\text{CH}_3)_2$ OR either $\text{CH}_3\text{COOCH}_2\text{CH}_2\text{CH}_3$ or $\text{CH}_3\text{COOCH}(\text{CH}_3)_2$ ✓ Must be consistent with a structure of alcohol X</p> <p>$m/z = 31$ is CH_2OH^+ ✓</p> <p>QWC $m/z = 31$ or CH_2OH indicates that X must be $\text{CH}_3\text{CH}_2\text{CH}_2\text{OH}$ OR cannot be $\text{CH}_3\text{CH}(\text{OH})\text{CH}_3$ OR shows that X is the primary alcohol ✓</p> <p>$\text{C}_3\text{H}_8\text{O} + \text{C}_2\text{H}_4\text{O}_2 \rightarrow \text{C}_5\text{H}_{10}\text{O}_2 + \text{H}_2\text{O}$ ✓</p>	6	<p>ALLOW correct structural OR displayed OR skeletal formula OR mixture of the above (as long as unambiguous)</p> <p>IGNORE names</p> <p>ALLOW a carboxylic acid reacts with an alcohol to give an ester. IGNORE ethanoic acid (as this is stated in the question)</p> <p>ALLOW correct structural OR displayed OR skeletal formula OR mixture of the above (as long as unambiguous)</p> <p>If no structure of X is provided one mark can be awarded for a correct structure of $\text{CH}_3\text{COOCH}_2\text{CH}_2\text{CH}_3$ OR $\text{CH}_3\text{COOCH}(\text{CH}_3)_2$</p> <p>DO NOT ALLOW CH_3O^+</p> <p>QWC must link the evidence to the structure of propan-1-ol.</p> <p>In equation ALLOW correct structural OR displayed OR skeletal formula OR mixture of the above</p>
	Total	10	

OCR (Oxford Cambridge and RSA Examinations)
1 Hills Road
Cambridge
CB1 2EU

OCR Customer Contact Centre

Education and Learning

Telephone: 01223 553998

Facsimile: 01223 552627

Email: general.qualifications@ocr.org.uk

www.ocr.org.uk

For staff training purposes and as part of our quality assurance programme your call may be recorded or monitored