



UNIVERSITY OF CAMBRIDGE INTERNATIONAL EXAMINATIONS
General Certificate of Education
Advanced Subsidiary Level and Advanced Level

PHYSICS**9702/11**

Paper 1 Multiple Choice

October/November 2009**1 hour**

Additional Materials: Multiple Choice Answer Sheet
 Soft clean eraser
 Soft pencil (type B or HB is recommended)



READ THESE INSTRUCTIONS FIRST

Write in soft pencil.

Do not use staples, paper clips, highlighters, glue or correction fluid.

Write your name, Centre number and candidate number on the Answer Sheet in the spaces provided unless this has been done for you.

There are **forty** questions on this paper. Answer **all** questions. For each question there are four possible answers **A, B, C** and **D**.Choose the **one** you consider correct and record your choice in **soft pencil** on the separate Answer Sheet.**Read the instructions on the Answer Sheet very carefully.**

Each correct answer will score one mark. A mark will not be deducted for a wrong answer.

Any working should be done in this booklet.

This document consists of **24** printed pages.

2**Data**

speed of light in free space,	$c = 3.00 \times 10^8 \text{ m s}^{-1}$
permeability of free space,	$\mu_0 = 4\pi \times 10^{-7} \text{ H m}^{-1}$
permittivity of free space,	$\epsilon_0 = 8.85 \times 10^{-12} \text{ F m}^{-1}$
elementary charge,	$e = 1.60 \times 10^{-19} \text{ C}$
the Planck constant,	$h = 6.63 \times 10^{-34} \text{ J s}$
unified atomic mass constant,	$u = 1.66 \times 10^{-27} \text{ kg}$
rest mass of electron,	$m_e = 9.11 \times 10^{-31} \text{ kg}$
rest mass of proton,	$m_p = 1.67 \times 10^{-27} \text{ kg}$
molar gas constant,	$R = 8.31 \text{ J K}^{-1} \text{ mol}^{-1}$
the Avogadro constant,	$N_A = 6.02 \times 10^{23} \text{ mol}^{-1}$
the Boltzmann constant,	$k = 1.38 \times 10^{-23} \text{ J K}^{-1}$
gravitational constant,	$G = 6.67 \times 10^{-11} \text{ N m}^2 \text{ kg}^{-2}$
acceleration of free fall,	$g = 9.81 \text{ m s}^{-2}$

3

Formulae

uniformly accelerated motion,	$s = ut + \frac{1}{2}at^2$ $v^2 = u^2 + 2as$
work done on/by a gas,	$W = p\Delta V$
gravitational potential,	$\phi = -\frac{Gm}{r}$
hydrostatic pressure,	$p = \rho gh$
pressure of an ideal gas,	$p = \frac{1}{3}\frac{Nm}{V}\langle c^2 \rangle$
simple harmonic motion,	$a = -\omega^2 x$
velocity of particle in s.h.m.,	$v = v_0 \cos \omega t$ $v = \pm \omega \sqrt{x_0^2 - x^2}$
electric potential,	$V = \frac{Q}{4\pi\epsilon_0 r}$
capacitors in series,	$1/C = 1/C_1 + 1/C_2 + \dots$
capacitors in parallel,	$C = C_1 + C_2 + \dots$
energy of charged capacitor,	$W = \frac{1}{2}QV$
resistors in series,	$R = R_1 + R_2 + \dots$
resistors in parallel,	$1/R = 1/R_1 + 1/R_2 + \dots$
alternating current/voltage,	$x = x_0 \sin \omega t$
radioactive decay,	$x = x_0 \exp(-\lambda t)$
decay constant,	$\lambda = \frac{0.693}{t_{\frac{1}{2}}}$

4

- 1 The drag force F acting on a moving sphere obeys an equation of the form $F = kAv^2$, where A represents the sphere's frontal area and v represents its speed.

What are the base units of the constant k ?

- A $\text{kg m}^5 \text{s}^{-4}$ B $\text{kg m}^{-2} \text{s}^{-1}$ C kg m^{-3} D $\text{kg m}^{-4} \text{s}^2$

- 2 The table contains some quantities, together with their symbols and units.

quantity	symbol	unit
gravitational field strength	g	N kg^{-1}
density of liquid	ρ	kg m^{-3}
vertical height	h	m
volume of part of liquid	V	m^3

Which expression has the units of energy?

- A $g\rho hV$ B $\frac{\rho hV}{g}$ C $\frac{\rho g}{hV}$ D $\rho g^2 h$

Space for working

5

- 3 The graph shows two current-voltage calibration curves for a solar cell exposed to different light intensities.

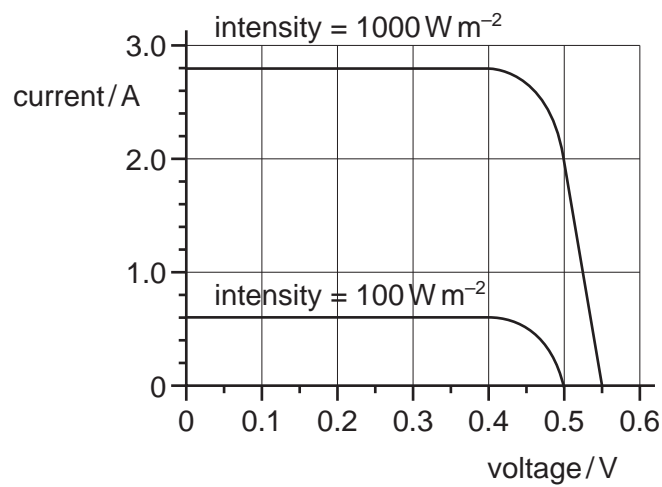

At zero voltage, what is the ratio $\frac{\text{current at } 1000 \text{ W m}^{-2}}{\text{current at } 100 \text{ W m}^{-2}}$?

- A 1.1 B 4.7 C 8.0 D 10

Space for working

6

- 4 The diagram shows an oscilloscope screen displaying two signals.

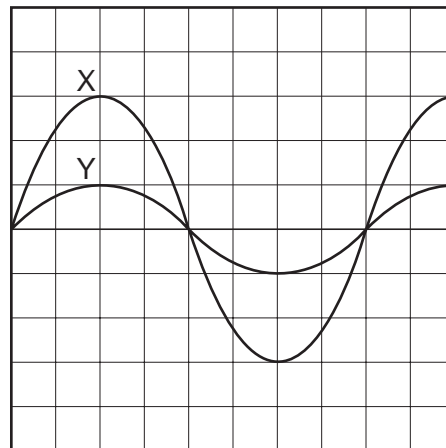

Signal X has a frequency of 50 Hz and peak voltage of 12 V.

What is the period and peak voltage of signal Y?

	period / ms	peak voltage / V
A	20	4
B	20	12
C	50	4
D	50	12

- 5 On a particular railway, a train driver applies the brake of the train at a yellow signal, a distance of 1.0 km from a red signal, where it stops.

The maximum deceleration of the train is 0.2 m s^{-2} .

Assuming uniform deceleration, what is the maximum safe speed of the train at the yellow signal?

- A** 20 m s^{-1} **B** 40 m s^{-1} **C** 200 m s^{-1} **D** 400 m s^{-1}

Space for working

7

- 6 A ball is released from rest above a horizontal surface and bounces several times. The graph shows how, for this ball, a quantity y varies with time.

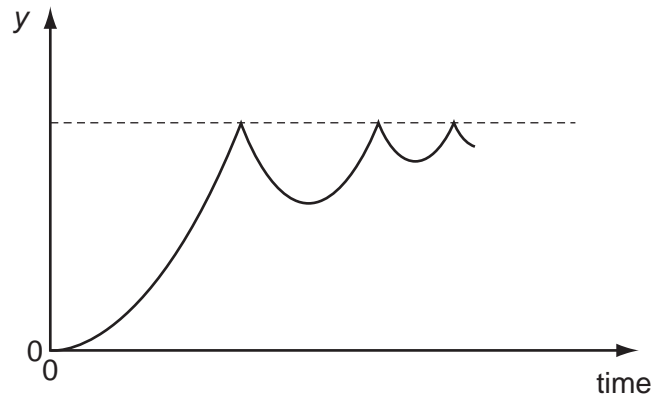

What is the quantity y ?

- A acceleration
- B displacement
- C kinetic energy
- D velocity

Space for working

8

7 The diagram shows a velocity-time graph.

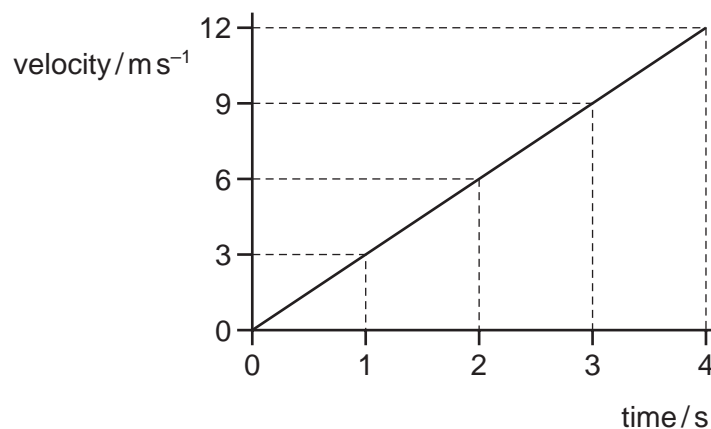

What is the displacement during the last 2 seconds of the motion?

- A** 6 m **B** 12 m **C** 18 m **D** 24 m

8 Which statement about a ball that strikes a tennis racket and rebounds is **always** correct?

- A** Total kinetic energy of the ball is conserved.
B Total kinetic energy of the system is conserved.
C Total momentum of the ball is conserved.
D Total momentum of the system is conserved.

Space for working

9

- 9 The diagram shows two spherical masses approaching each other head-on at an equal speed u . One has mass $2m$ and the other has mass m .



Which diagram, showing the situation after the collision, shows the result of an elastic collision?

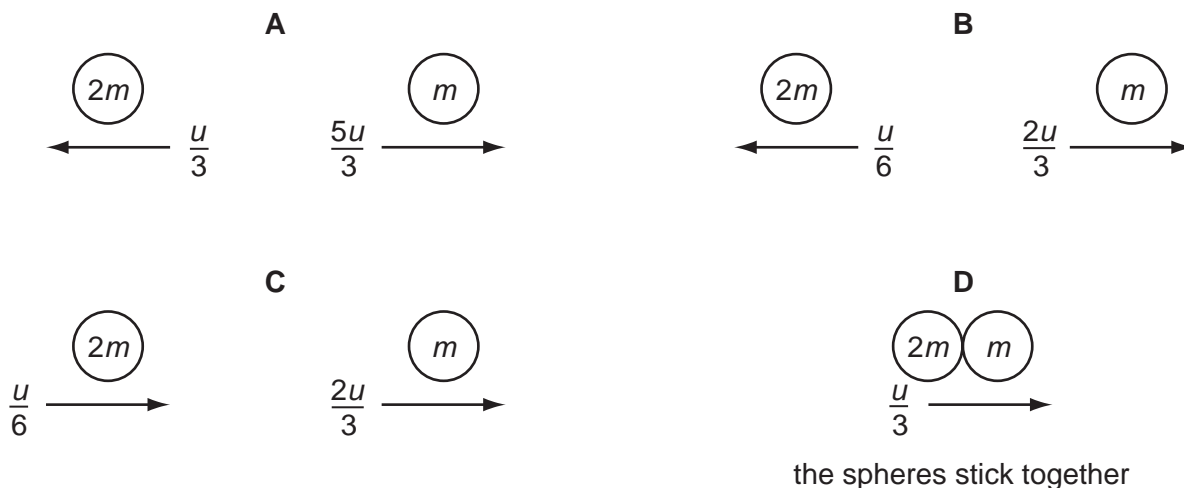

- 10 A supermarket trolley, total mass 30 kg, is moving at 3.0 m s^{-1} . A retarding force of 60 N is applied to the trolley for 0.50 s in the opposite direction to the trolley's initial velocity.

What is the trolley's new velocity after the application of the force?

- A 1.0 m s^{-1} B 1.5 m s^{-1} C 2.0 m s^{-1} D 2.8 m s^{-1}

Space for working

10

11 What is the centre of gravity of an object?

- A the geometrical centre of the object
- B the point about which the total torque is zero
- C the point at which the weight of the object may be considered to act
- D the point through which gravity acts

12 The diagrams show two ways of hanging the same picture.

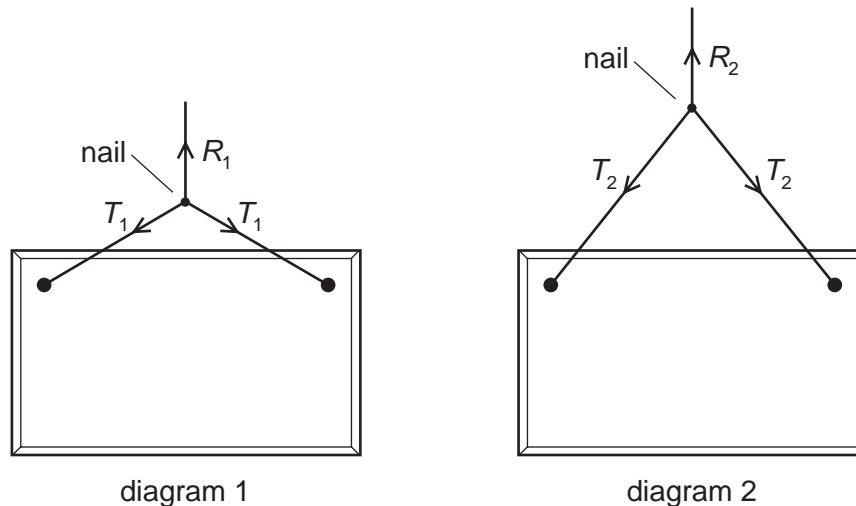

In both cases, a string is attached to the same points on the picture and looped symmetrically over a nail in a wall. The forces shown are those that act on the nail.

In diagram 1, the string loop is shorter than in diagram 2.

Which information about the magnitude of the forces is correct?

- A $R_1 = R_2$ $T_1 = T_2$
- B $R_1 = R_2$ $T_1 > T_2$
- C $R_1 > R_2$ $T_1 < T_2$
- D $R_1 < R_2$ $T_1 = T_2$

Space for working

11

- 13 The diagram shows two pulley wheels connected by a belt.

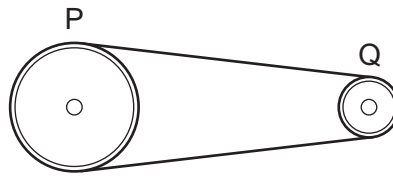

Wheel Q is driven by a motor and rotates clockwise at a constant rate. Wheel Q puts tension in the top portion of the belt, which in turn drives the wheel P. The lower portion of the belt is slack and has no tension. The weight of the belt and frictional forces are negligible.

The diameter of P is 150 mm. The diameter of Q is 100 mm. The torque applied to Q is 3.0 N m.

What is the tension in the belt and the torque on wheel P?

	tension in top of belt /N	torque on wheel P /Nm
A	20	2.0
B	30	4.5
C	40	2.0
D	60	4.5

- 14 A projectile is launched at 45° to the horizontal with initial kinetic energy E .

Assuming air resistance to be negligible, what will be the kinetic energy of the projectile when it reaches its highest point?

- A** $0.50E$ **B** $0.71E$ **C** $0.87E$ **D** E

Space for working

12

- 15 Two trolleys are placed together on a horizontal runway with a compressed spring between them.

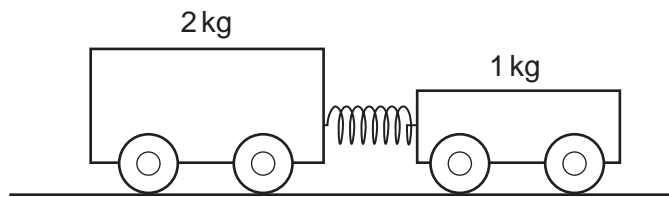

When they are released, the 2 kg trolley moves to the left at 2 m s^{-1} .

How much energy was stored in the spring?

- A** 4 J **B** 6 J **C** 8 J **D** 12 J
- 16 An electric railway locomotive has a maximum mechanical output power of 4.0 MW. Electrical power is delivered at 25 kV from overhead wires. The overall efficiency of the locomotive in converting electrical power to mechanical power is 80%.

What is the current from the overhead wires when the locomotive is operating at its maximum power?

- A** 130 A **B** 160 A **C** 200 A **D** 250 A

Space for working

13

17 The diagram shows an ice cube floating in water.

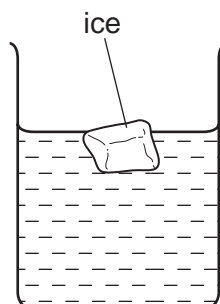

Both the ice cube and the water are at 0°C .

Which statement correctly compares the molecular properties of the ice and those of the water?

- A The mean inter-molecular potential energies are the same for both the ice molecules and the water molecules.
- B The mean inter-molecular separations are the same for both the ice and the water.
- C The mean kinetic energies are the same for both the ice molecules and the water molecules.
- D The mean total energies are the same for both the ice molecules and the water molecules.

Space for working

14

18 In the kinetic model of gases, what is pressure equal to?

- A the number of atoms hitting and rebounding from a surface of the gas container
- B the number of atoms hitting and rebounding from a unit area of the gas container surface
- C the force exerted by the atoms hitting and rebounding from a surface of the gas container
- D the force exerted by the atoms hitting and rebounding from a unit area of the gas container surface

19 A rectangular metal bar exerts a pressure of 15 200 Pa on the horizontal surface on which it rests.

If the height of the metal bar is 80 cm, what is the density of the metal?

- A 190 kg m^{-3}
- B 1900 kg m^{-3}
- C $19\,000 \text{ kg m}^{-3}$
- D $190\,000 \text{ kg m}^{-3}$

20 Which row best defines elastic and plastic behaviour of a material?

	elastic behaviour of a material	plastic behaviour of a material
A	extends only within the limit of proportionality	extends beyond the limit of proportionality
B	has a linear force-extension curve	has a horizontal force-extension curve
C	obeys Hooke's Law	extends continuously under a steady load
D	returns to its original shape and size	suffers permanent deformation

Space for working

15

- 21 The graph shows the non-linear force-extension curve for a wire made from a new composite material.

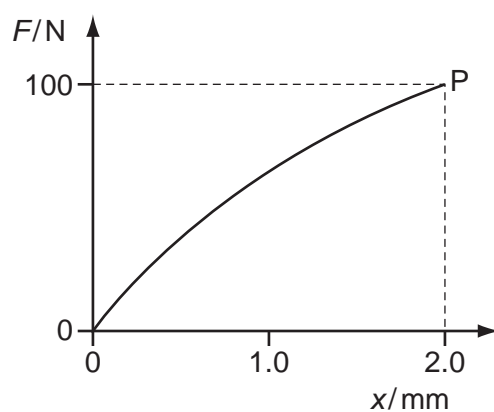

What could be the value of the strain energy stored in the wire when it is stretched to point P?

- A** 0.09 J **B** 0.10 J **C** 0.11 J **D** 0.20 J
- 22 A steel string on an electric guitar has the following properties.
- diameter = 5.0×10^{-4} m
Young modulus = 2.0×10^{11} Pa
tension = 20 N
- The string snaps, and contracts elastically.
- By what percentage does a length l of a piece of the string contract?
- A** $5.1 \times 10^{-4}\%$ **B** $5.1 \times 10^{-2}\%$ **C** $1.3 \times 10^{-4}\%$ **D** $1.3 \times 10^{-2}\%$

Space for working

16

- 23 The order of magnitude of the frequency of the longest-wavelength ultraviolet waves can be expressed as 10^x Hz.

What is the value of x ?

- A 13 B 15 C 17 D 19

- 24 The light from two lasers passes through a vacuum. One laser emits red light and the other emits green light.

Which property of the two laser beams must be different?

- A amplitude
B frequency
C plane of polarisation
D speed

- 25 The diagram shows a standing wave on a string. The standing wave has three nodes N_1 , N_2 and N_3 .

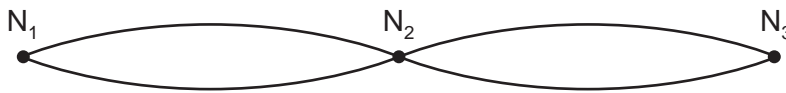

Which statement is correct?

- A All points on the string vibrate in phase.
B All points on the string vibrate with the same amplitude.
C Points equidistant from N_2 vibrate with the same frequency and in phase.
D Points equidistant from N_2 vibrate with the same frequency and the same amplitude.
- 26 A parallel beam of light of wavelength 450 nm falls normally on a diffraction grating which has 300 lines/mm.

What is the total number of transmitted maxima?

- A 7 B 8 C 14 D 15

Space for working

27 A small charge q is placed in the electric field of a large charge Q .

Both charges experience a force F .

What is the electric field strength of the charge Q at the position of the charge q ?

- A $\frac{F}{Qq}$ B $\frac{F}{Q}$ C FqQ D $\frac{F}{q}$

28 The diagram shows two parallel horizontal metal plates held at a potential difference V .

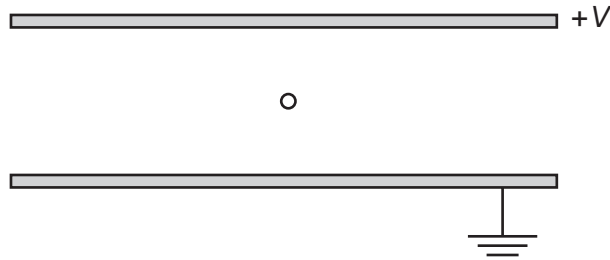

A small charged liquid drop, midway between the plates, is held in equilibrium by the combination of its weight and the electric force acting on it.

The acceleration of free fall is g and the electric field strength is E .

What is the ratio of the charge to mass of the drop, and the polarity of the charge on the drop?

	$\frac{\text{charge}}{\text{mass}}$	polarity
A	$\frac{g}{E}$	positive
B	$\frac{g}{E}$	negative
C	$\frac{E}{g}$	positive
D	$\frac{E}{g}$	negative

Space for working

18

29 The electric field at a certain distance from an isolated alpha particle is $3.0 \times 10^7 \text{ NC}^{-1}$.

What is the force on an electron when at that distance from the alpha particle?

- A $4.8 \times 10^{-12} \text{ N}$
- B $9.6 \times 10^{-12} \text{ N}$
- C $3.0 \times 10^7 \text{ N}$
- D $6.0 \times 10^7 \text{ N}$

30 A cell is connected to a resistor.

At any given moment, the potential difference across the cell is less than its electromotive force.

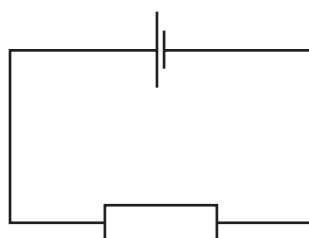

Which statement explains this?

- A The cell is continually discharging.
- B The connecting wire has some resistance.
- C Energy is needed to drive charge through the cell.
- D Power is used when there is a current in the resistor.

Space for working

19

31 Which values of current and resistance will produce a rate of energy transfer of 16 J s^{-1} ?

	current/A	resistance/ Ω
A	1	4
B	2	8
C	4	1
D	16	1

32 A cylindrical wire 4.0 m long has a resistance of 31Ω and is made of metal of resistivity $1.0 \times 10^{-6} \Omega \text{ m}$.

What is the radius of cross-section of the wire?

- A** $1.0 \times 10^{-8} \text{ m}$
- B** $2.0 \times 10^{-8} \text{ m}$
- C** $6.4 \times 10^{-8} \text{ m}$
- D** $2.0 \times 10^{-4} \text{ m}$

Space for working

20

33 Each of Kirchhoff's two laws presumes that some quantity is conserved.

Which row states Kirchhoff's **first** law and names the quantity that is conserved?

	statement	quantity
A	the algebraic sum of currents into a junction is zero	charge
B	the algebraic sum of currents into a junction is zero	energy
C	the e.m.f. in a loop is equal to the algebraic sum of the product of current and resistance round the loop	charge
D	the e.m.f. in a loop is equal to the algebraic sum of the product of current and resistance round the loop	energy

34 The diagram shows the symbol for a wire carrying a current I .

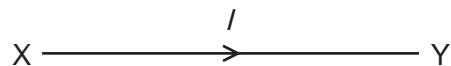

What does this current represent?

- A** the amount of charge flowing past a point in XY per second
- B** the number of electrons flowing past a point in XY per second
- C** the number of positive ions flowing past a point in XY per second
- D** the number of protons flowing past a point in XY per second

Space for working

- 35 A potential divider consisting of resistors of resistance R_1 and R_2 is connected to an input potential difference of V_0 and gives an output p.d. of V .

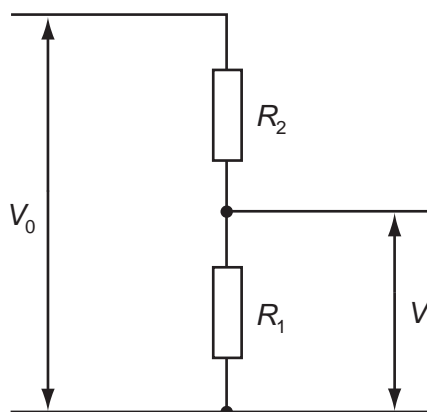

What is the value of V ?

- A $\frac{V_0 R_1}{R_2}$ B $\frac{V_0 R_1}{R_1 + R_2}$ C $\frac{V_0 R_2}{R_1 + R_2}$ D $\frac{V_0 (R_1 + R_2)}{R_1}$

- 36 A network of resistors consists of two $3.0\ \Omega$ resistors and three $6.0\ \Omega$ resistors.

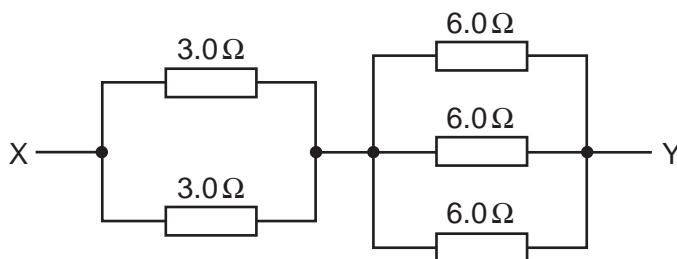

What is the combined resistance of this network between points X and Y?

- A $0.86\ \Omega$ B $1.2\ \Omega$ C $3.5\ \Omega$ D $24\ \Omega$

Space for working

22

37 The gold nucleus ${}_{79}^{185}\text{Au}$ undergoes alpha decay.

What are the nucleon (mass) number and proton (atomic) number of the nucleus formed by this decay?

	nucleon number	proton number
A	183	79
B	183	77
C	181	77
D	181	75

38 The nuclei of the isotopes of an element all contain the same number of a certain particle.

What is this particle?

- A** electron
- B** neutron
- C** nucleon
- D** proton

Space for working

39 Alpha, beta and gamma radiations

- 1 are absorbed to different extents in solids,
- 2 behave differently in an electric field,
- 3 behave differently in a magnetic field.

The diagrams illustrate these behaviours.

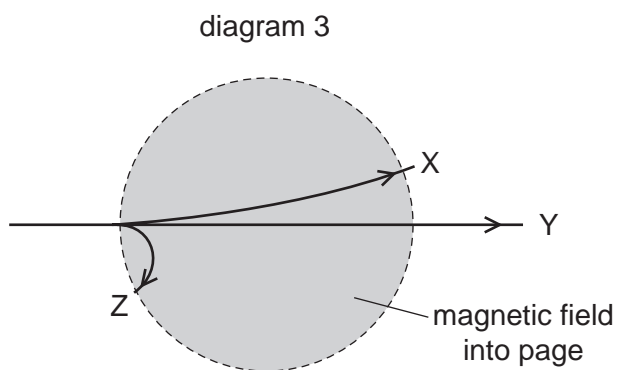
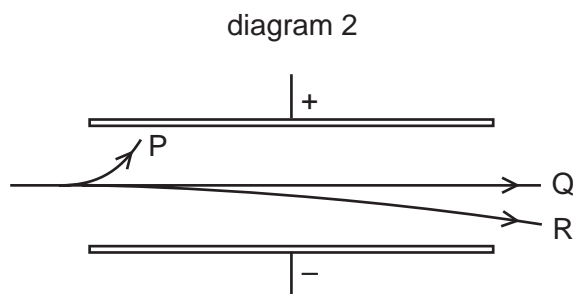
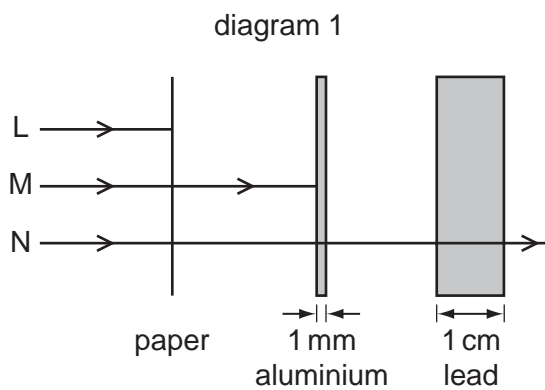

Which three labels on these diagrams refer to the **same** kind of radiation?

- A** L, P, X **B** L, P, Z **C** M, P, Z **D** N, Q, X

Space for working

40 Two α -particles with equal energies are fired towards the nucleus of a gold atom.

Which diagram best represents their paths?

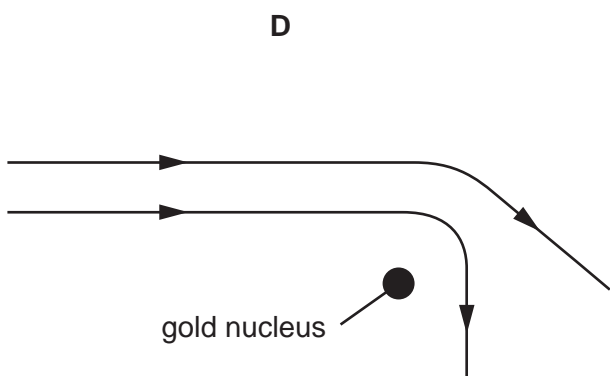
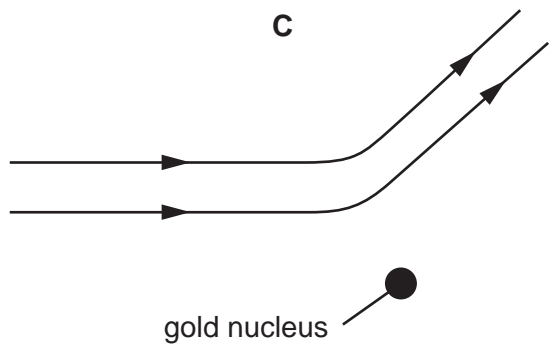
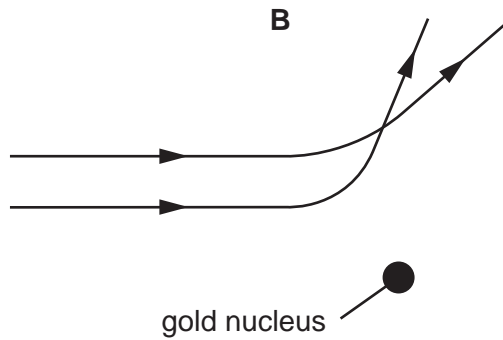
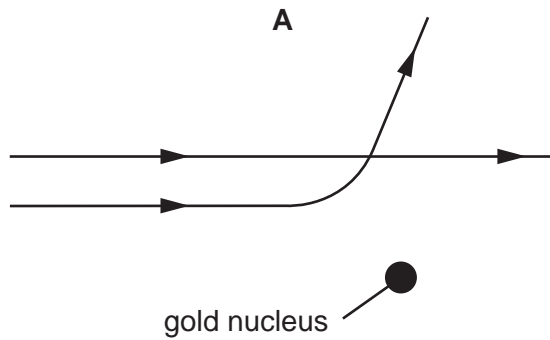

Space for working

Permission to reproduce items where third-party owned material protected by copyright is included has been sought and cleared where possible. Every reasonable effort has been made by the publisher (UCLES) to trace copyright holders, but if any items requiring clearance have unwittingly been included, the publisher will be pleased to make amends at the earliest possible opportunity.

University of Cambridge International Examinations is part of the Cambridge Assessment Group. Cambridge Assessment is the brand name of University of Cambridge Local Examinations Syndicate (UCLES), which is itself a department of the University of Cambridge.