

Surname	Centre Number	Candidate Number
Other Names		2



GCE A level

1324/01

PHYSICS

ASSESSMENT UNIT PH4: Oscillations and Fields

P.M. THURSDAY, 13 June 2013

1½ hours

For Examiner's use only		
1.	11	
2.	11	
3.	11	
4.	18	
5.	8	
6.	11	
7.	10	
Total	80	

1324
010001

ADDITIONAL MATERIALS

In addition to this examination paper, you will require a calculator and a **Data Booklet**.

INSTRUCTIONS TO CANDIDATES

Use black ink or black ball-point pen.

Write your name, centre number and candidate number in the spaces at the top of this page.

Answer **all** questions.

Write your answers in the spaces provided in this booklet.

INFORMATION FOR CANDIDATES

The total number of marks available for this paper is 80.

The number of marks is given in brackets at the end of each question or part question.

You are reminded of the necessity for good English and orderly presentation in your answers.

You are reminded to show all working. Credit is given for correct working even when the final answer given is incorrect.

1. A container fitted with a leak-proof moveable piston at one end contains 0.06 mol of a monatomic ideal gas. The gas is initially at a pressure 8.5×10^4 Pa and temperature 250 K.



The gas is taken from this initial state A through a cycle (A→B→C→A) in three stages.

Stage	Process
A→B	Constant pressure expansion to temperature 355 K.
B→C	Constant temperature expansion to pressure 7.0×10^4 Pa.
C→A	Compression where the pressure increases linearly with decreasing volume to return to the initial state.

- (a) Draw the cycle on the axes below showing each stage clearly and indicating the **direction** of each stage. The first stage A→B is already done for you. (No *numerical* values are needed.) [3]

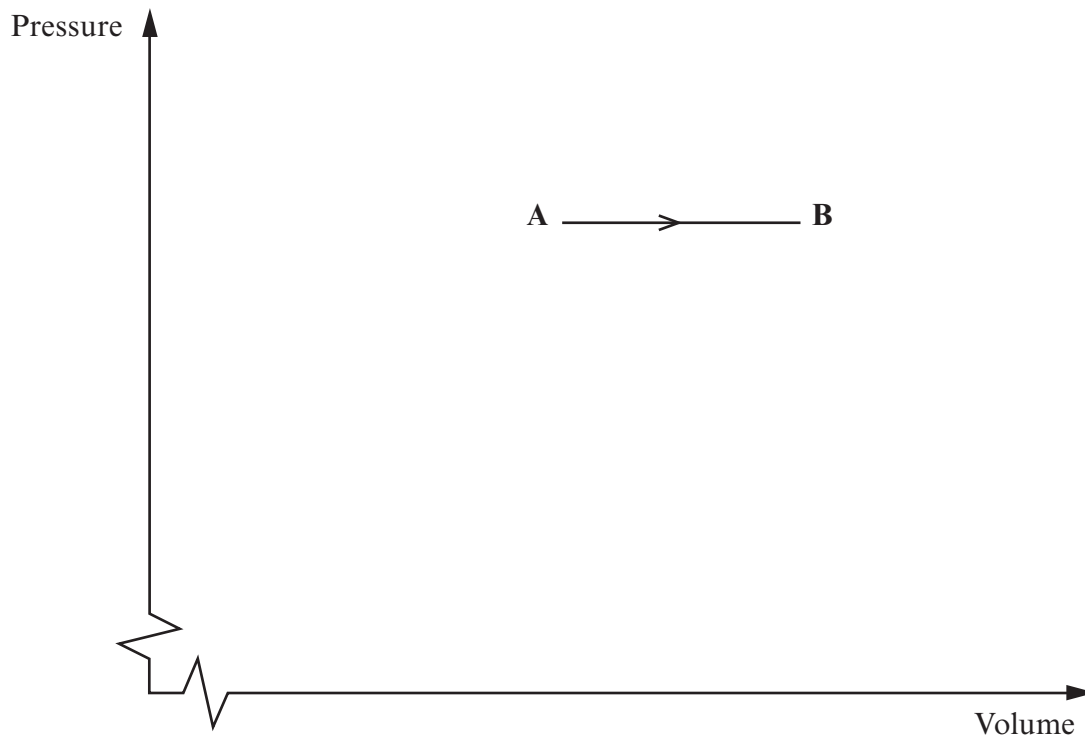

(b) Calculate the volume of the gas at:

[3]

(i) **A**;

.....

.....

.....

(ii) **B**;

.....

.....

.....

(iii) **C**.

.....

.....

.....

(c) Show that the work done by the gas during:

[3]

(i) Stage **A→B** is approximately +52 J;

.....

.....

.....

(ii) Stage **C→A** is approximately -82 J.

.....

.....

.....

(d) Complete the table below.

[2]

Stage	$\Delta U / \text{J}$	W / J	Q / J
A→B	+79	+52	
B→C	0	+34	
C→A		-82	

1324
010003

2. A container made of insulating material contains $1.7 \times 10^{-3} \text{ m}^3$ of water. The water is heated by a 3 kW electric immersion heater. A student records the water temperature at 0.5 minute intervals.

Time / min	Temperature of water / °C
0.5	32.5
1.0	45.0
1.5	57.5
2.0	70.5
2.5	83.0
3.0	95.5

- (a) The density of water is $1.0 \times 10^3 \text{ kg m}^{-3}$. Calculate the mass of the water. [1]

.....

.....

- (b) Plot a graph of the water temperature against time in minutes. [2]

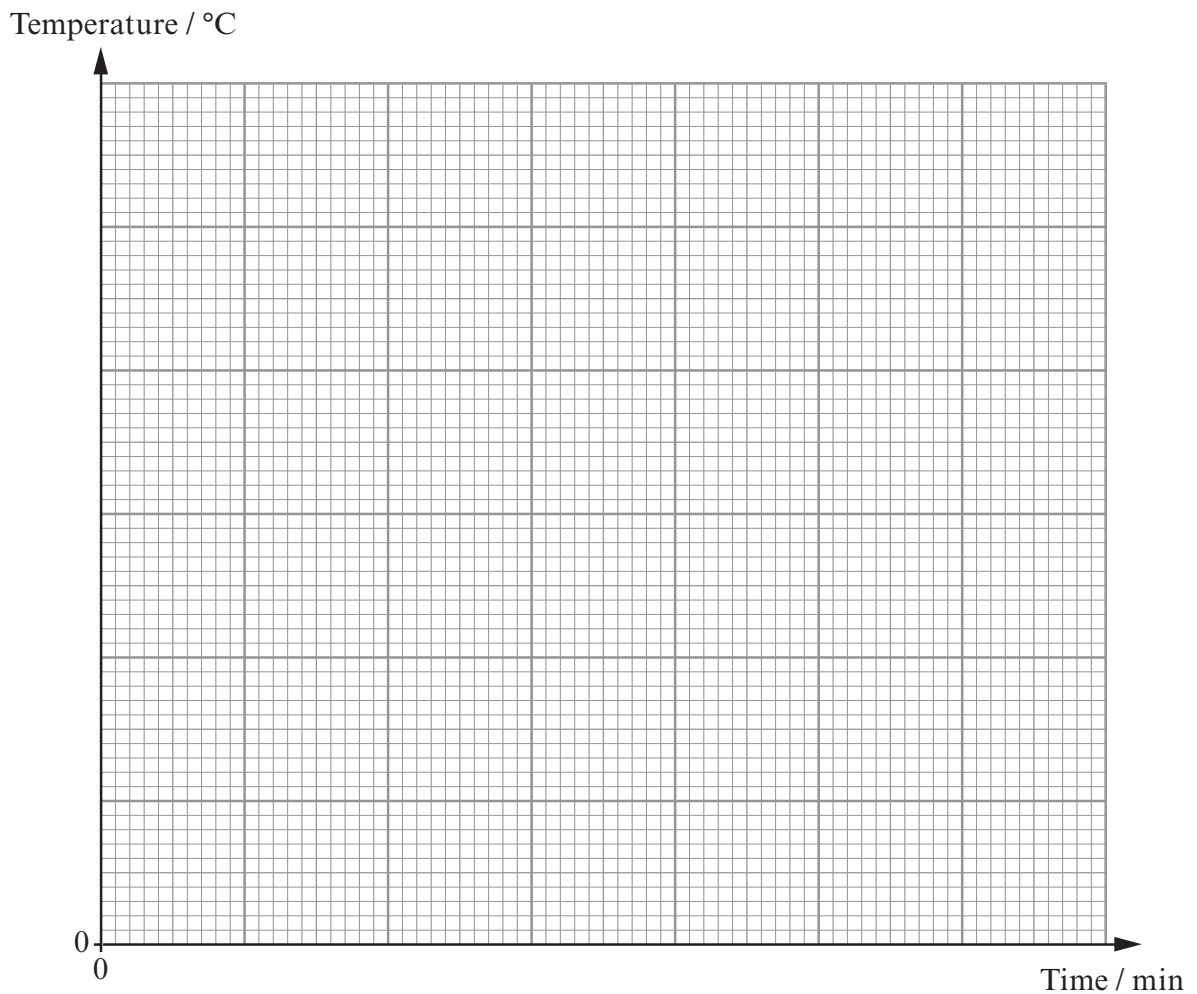

Examiner
only

(c) Estimate the original temperature of the water. [1]

(d) If the heating continues, how long after the start of heating will the water boil? [1]

(e) The power of the heater is 3 kW. Determine a value for the specific heat capacity of the water in the insulating container. [3]

(f) The student repeats the experiment but uses a container that is not such a good insulator. Readings are obtained at the same time intervals as before. State what happens to the:

- (i) values of temperature;
- (ii) gradient of the graph;
- (iii) value obtained for the specific heat capacity.

Calculations are not required. [3]

1324
010005

3. A car suspension is modelled as a 2000 kg platform supported on a spring resting on a wheel base. When supporting the platform the spring is compressed 15.0 cm from its natural length.

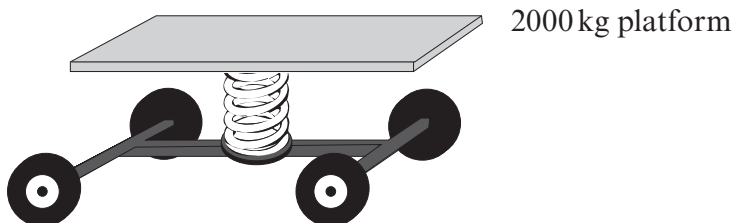

- (a) Calculate the spring constant. [2]

.....

.....

.....

- (b) Two passengers, of masses 75 kg and 85 kg, sit on the platform.
- (i) Calculate the additional compression of the spring. [2]

.....

.....

.....

- (ii) Determine the period of the natural oscillation of the system. [2]

.....

.....

.....

- (iii) The car travels over a series of speed humps. This results in a driving force of frequency 1.24 Hz. Explain what happens to the oscillation of the platform in the suspension system. [2]

.....

.....

.....

.....



(c) Explain the purpose of damping in a car suspension system.

[3]

Examiner
only

.....

.....

.....

.....

.....

.....

.....

1324
010007

4. A rod is attached vertically to a horizontal turntable at point **P**, 0.080 m from the centre **Q**.

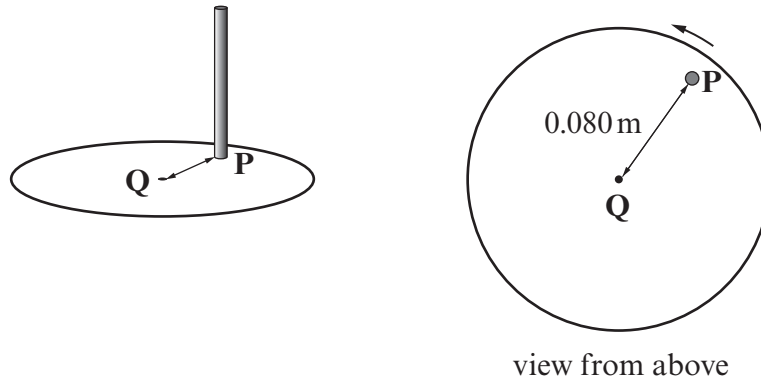

(a) (i) The turntable rotates around **Q** at 45 rotations per minute. Show that its angular speed ω is 4.71 rad s^{-1} . [2]

.....

.....

.....

(ii) Calculate the speed v of the rod. [2]

.....

.....

.....

(iii) Calculate the acceleration of the rod. [2]

.....

.....

.....

(iv) State the direction of the acceleration of the rod. [1]

.....

(b) When the rod is illuminated from the side its shadow on a screen oscillates with Simple Harmonic Motion (SHM).

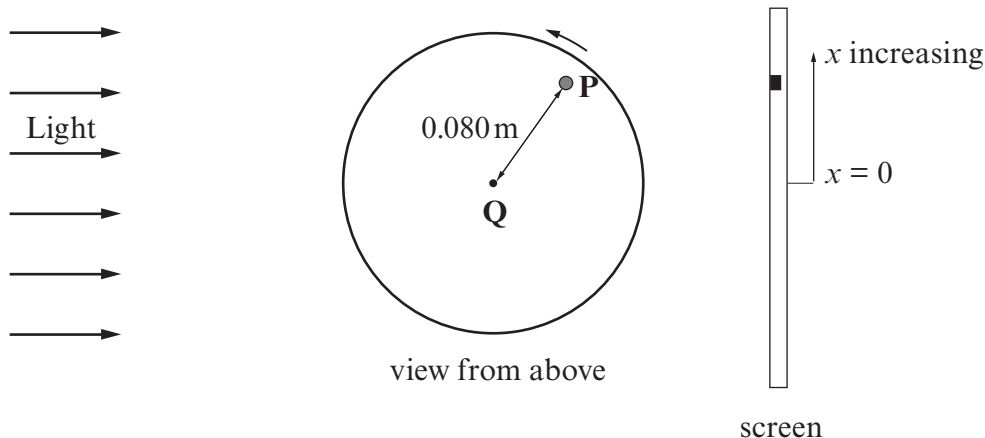

The displacement x in metres of the centre of the shadow from the centre of oscillation and the acceleration a of the shadow may be written

$$x = A\sin(\omega t) \quad \text{and} \quad a = -\omega^2 A\sin(\omega t)$$

where t is time in seconds, A is the amplitude of oscillation and $\omega = 4.71 \text{ rad s}^{-1}$.

(i) Write the value of A [1]

(ii) Calculate the value of the period of oscillation. [1]

.....
.....

(iii) Calculate the acceleration of the shadow at time $t = 0.20 \text{ s}$. [2]

.....
.....
.....

(iv) State what is meant by *Simple Harmonic Motion* (SHM). [2]

.....

.....

.....

(v) Show clearly that the expressions for x and a agree with the definition of SHM. [2]

.....

.....

.....

(c) A second rod is now attached vertically to the turntable at point **R**, 0.060 m from centre **Q**, such that angle **PQR** is a right angle.

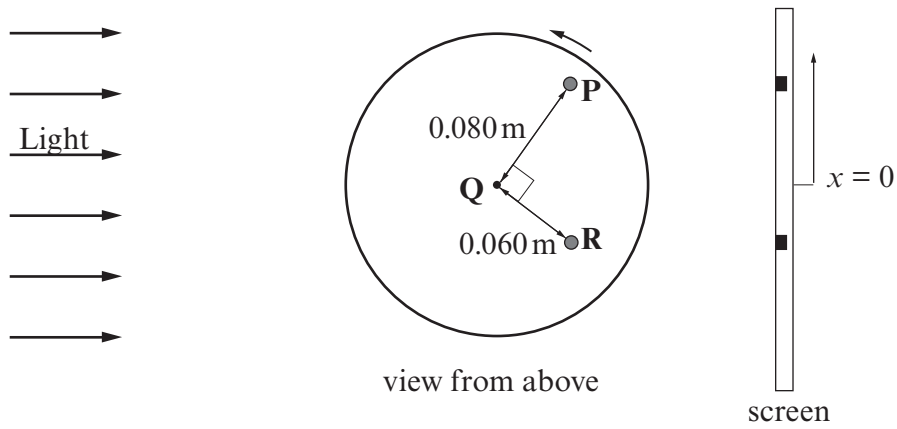

Complete the expression for the displacement of the shadow of the second rod at time t seconds by inserting numerical values in the boxes. [3]

$$x_R = \boxed{} \sin \left[\boxed{} t - \boxed{} \right]$$

5.

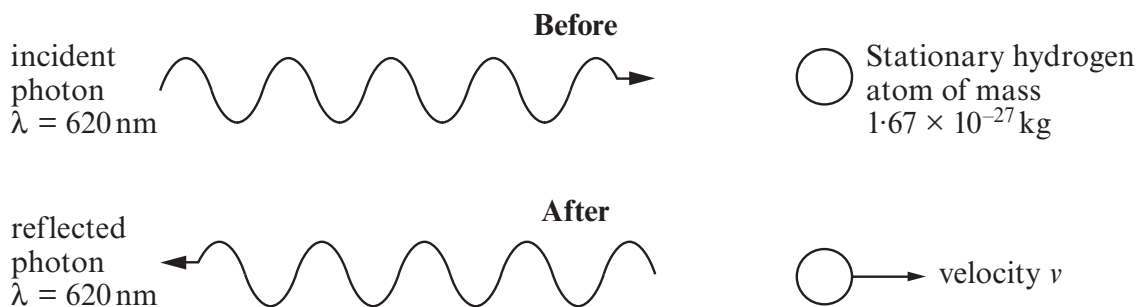

(a) A photon of wavelength 620 nm strikes a stationary hydrogen atom head-on and rebounds directly backwards. Assume that the wavelength of the photon is unchanged.

(i) State the principle of *conservation of momentum*. [2]

.....

.....

.....

(ii) Show that the speed of the hydrogen atom immediately after impact is 1.28 m s^{-1} . [2]

.....

.....

.....

.....

.....

(iii) Calculate the energy of the photon. [1]

.....

.....

(b) (i) Determine the wavelength of a photon that has the same momentum as a hydrogen atom moving with the speed of 1.28 m s^{-1} . [2]

.....

.....

.....

.....

(ii) Identify the type of electromagnetic radiation of **this** photon. [1]

.....

6. Information about the Earth, Jupiter and the Sun is given in the table:

	Radius / m	Mass / kg	Distance from the Sun / m
Earth	6.37×10^6	5.97×10^{24}	1.50×10^{11}
Jupiter	6.99×10^7	1.90×10^{27}	7.79×10^{11}
Sun	6.96×10^8	1.99×10^{30}	–

(a) Determine the following at the position of the Earth.

(i) The gravitational field strength of the Sun. [2]

.....

.....

.....

.....

(ii) The gravitational potential due to the Sun. [2]

.....

.....

.....

.....

(b) (i) Show clearly that the centre of mass of the Sun-Jupiter system lies outside the Sun. [3]

.....

.....

.....

.....

.....

(ii) Estimate the speed of the Sun's core around this centre of mass.

[4]

Examiner
only

.....

.....

.....

.....

.....

.....

.....

7. Two spherical balloons each of mass m carry equal numbers of excess electrons distributed uniformly over their surfaces. The total excess charge on each balloon is $-2.55 \times 10^{-7} \text{ C}$.

When both balloons are hung from the same point by light strings of lengths 0.75 m , each string makes an angle of 10° with the vertical.

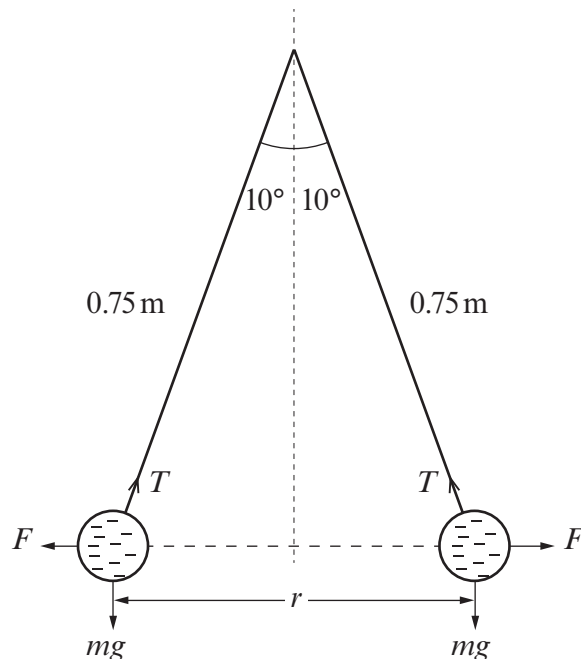

The weight mg of each balloon, the electrostatic forces F acting on each balloon and the tensions T in the strings are shown in the diagram.

- (a) (i) Use the information in the diagram to show that the separation r of the centres of the balloons is approximately 0.26 m . [2]

.....

.....

.....

.....

- (ii) Calculate the electrostatic force F on each balloon. [2]

.....

.....

.....

.....

Examiner
only

(iii) Show that the electrostatic potential energy of the system is $2.25 \times 10^{-3} \text{ J}$. [2]

.....

.....

.....

.....

(b) (i) Use the answer to (a)(ii) to show that the tension T in each string is 0.050 N . [3]

.....

.....

.....

.....

(ii) Hence calculate the mass of each balloon. [1]

.....

.....

.....

END OF PAPER